



Apollo IV Pentium
PCI ISA Motherboard*Guide*

MAN-772
11/21/97

© Copyright 1997 American Megatrends, Inc.
All rights reserved.
American Megatrends, Inc.
6145F Northbelt Parkway
Norcross, GA 30071

This publication contains proprietary information which is protected by copyright. No part of this publication may be reproduced, transcribed, stored in a retrieval system, translated into any language or computer language, or transmitted in any form whatsoever without the prior written consent of the publisher, American Megatrends, Inc.

Limited Warranty

Buyer agrees if this product proves to be defective, that American Megatrends, Inc. is only obligated to replace or refund the purchase price of this product at American Megatrends' discretion according to the terms and conditions on the motherboard warranty card. American Megatrends shall not be liable in tort or contract for any loss or damage, direct, incidental or consequential. Please see the Warranty Registration Card shipped with this product for full warranty details.

Limitations of Liability

In no event shall American Megatrends be held liable for any loss, expenses, or damages of any kind whatsoever, whether direct, indirect, incidental, or consequential, arising from the design or use of this product or the support materials provided with the product.

Trademarks

Intel and Pentium are registered trademarks of Intel Corporation.
MS-DOS, Microsoft Word, and Microsoft are registered trademarks of Microsoft Corporation. Microsoft Windows 95 and Windows NT are trademarks of Microsoft Corporation.
IBM, AT, VGA, PS/2, OS/2, and EGA are registered trademarks of International Business Machines Corporation. XT and CGA are trademarks of International Business Machines Corporation.
Fujitsu is a registered trademark of Fujitsu America, Inc.
Motorola is a registered trademark of Motorola Corporation.
Hitachi is a registered trademark of Hitachi America, Ltd.
NEC is a registered trademark of NEC Corporation.
Samsung is a registered trademark of Samsung Electronics Corporation.
Siemens is a trademark of Siemens Corporation.
Mitsubishi is a registered trademark of Mitsubishi Electronics of America.
Micron is a registered trademark of Micron Corporation.
SCO, UnixWare, and Unix are registered trademarks of The Santa Cruz Operation, Inc.
Toshiba is a registered trademark of Kabushiki Kaisha Toshiba.
VESA is a trademark of the Video Electronics Standards Association.
All other brand and product names are trademarks or registered trademarks of their respective companies.

Revision History

11/21/97 Initial release.

Preface

To the OEM Thank you for purchasing the high performance American Megatrends Apollo IV PCI Pentium ISA motherboard. This product is a state of the art motherboard that includes the famous AMIBIOS. It is assumed that you have also licensed the rights to use the American Megatrends documentation for the American Megatrends Apollo IV motherboard

This manual was written for the OEM to assist in the proper installation and operation of this motherboard. This manual describes the specifications and features of the Apollo IV motherboard. It explains how to assemble a system based on the Apollo IV motherboard and how to use the AMIBIOS that is specifically designed for this motherboard.

This manual is not meant to be read by the computer owner who purchases a computer with this motherboard. It is assumed that you, the computer manufacturer, will use this manual as a sourcebook of information, and that parts of this manual will be included in the computer owner's manual.

Technical Support

If you need help installing, configuring, or running this product, call American Megatrends technical support at 770-246-8645. You can also send questions to tech support at:

support@ami.com.

American Megatrends BBS The American Megatrends BBS permits you to access technical information about American Megatrends motherboard, peripheral, and BIOS products. Product Engineering Change Notices, Tech Tips, and technical documentation are available on the BBS. Some parts of the BBS are not accessible to all callers. Call American Megatrends Technical Support at 770-246-8645 to find out how to access the BBS.

Phone Numbers The BBS requires no parity, eight data bits, and one stop bit. The characteristics of the BBS phone numbers are:

Phone Number	Characteristics
770-246-8780	28,800 baud rate. Supports v.34.
770-246-8781	28,800 baud rate. Supports v.34.
770-246-8782	Supports HST and v.42.
770-246-8783	Supports HST and v.42.

Web Site We invite you to access the American Megatrends world wide web site at:
<http://www.ami.com>.

Packing List

You should have received the following:

- an Apollo IV Pentium PCI ISA motherboard,
- a diskette containing the DMI Wizard 95 utility,
- the *American Megatrends DMI Wizard 95 User's Guide*,
- an optional USB cable and mounting bracket,
- two serial cables,
- one parallel cable,
- a Warranty Card, and
- the *American Megatrends Apollo IV Pentium ISA Motherboard User's Guide*.

Warning

The pinout for the optional USB Cable Box is:

Pin 1	Red	VCC
Pin 2	Green	Data +
Pin 3	White	Data -
Pin 4	Black	Ground

Please make sure that the USB cable is correctly installed. Incorrect installation will damage the motherboard.

Static Electricity

The Apollo IV motherboard can easily be damaged by static electricity. Make sure you take appropriate precautions against static electric discharge:

- wear a properly-grounded wristband while handling the motherboard or any other electrical component,
 - touch a grounded anti-static surface or a grounded metal fixture before handling the Apollo IV motherboard,
 - handle system components by the mounting bracket, if possible.
-

Batteries

Make sure you dispose of used batteries according to the battery manufacturer's instructions. Improper use of batteries may cause an explosion. Make sure you follow the battery manufacturer's instructions about using the battery. Replace used batteries with the same type of battery or an equivalent recommended by the battery manufacturer.

1 Hardware Installation

Overview

The American Megatrends Apollo IV PCI Pentium ISA motherboard includes the following features.

CPU

The CPU socket on the motherboard is a 321-pin ZIF socket. A switching voltage regulator is required. You can install any of the following CPUs:

CPU Manufacturer	Supported CPU Speeds
Intel® Pentium P55C	166, 200, and 233 MHz
Intel Pentium P54C with MMX™ technology	90, 100, 120, 133, 150, 166, and 200 MHz
AMD® K6-166	166 MHz
AMD K6-200	200 MHz
AMD K6-233	233 MHz
AMD K5-PR90	90 MHz
AMD K5-PR100	100 MHz
AMD K5-PR120	90 MHz
AMD K5-PR133	100 MHz
AMD K5-PR150	105 MHz
AMD K5-PR166	116 MHz
AMD K5-PR200	133 MHz

MMX Technology This motherboard supports CPUs that include support for Intel MMX technology. MMX technology allows you to experience richer video, audio, digital imaging and communications when running the latest generation of multimedia software on your computer.

Cont'd

Overview, Continued

Chipset The Apollo IV PCI Pentium ISA baby-AT size motherboard uses an Intel 430TX chipset, including CPU interface controller, advanced cache controller, integrated DRAM controller, synchronous ISA bus controller, PCI local bus interface, and an integrated power management unit. The Intel 430TX chipset supports intelligent diagnostic and power management through features such as DMI support.

Expansion Slots The motherboard includes:

- three 16-bit ISA expansion slots and
- four 32-bit PCI expansion slots.

The PCI local bus throughput can be up to 132 megabytes per second.

L1 Internal Cache The Intel Pentium on the motherboard has an 8 KB data cache and an 8 KB instruction cache.

L2 Secondary Cache The motherboard has 512 KB of pipeline burst direct-mapped, WriteBack L2 secondary cache memory. Up to 256 MB of system memory can be cached.

Supported Standards The Apollo IV motherboard supports:

- DMI,
 - the Intel DPMA (Dynamic Power Management Architecture),
 - Concurrent PCI V2.0 and V2.1, and
 - USB (Universal Serial Bus).
-

Switching Voltage Regulator This motherboard includes a switching voltage regulator that significantly reduces the CPU and voltage regulator temperature. This voltage regulator is also fully upgradable to the next generation of Socket 7 CPUs. These new CPUs will require more electrical current and will generate more heat.

Cont'd

CPU Thermal Monitor The Apollo IV motherboard includes a special heat sensor under the CPU that monitors the CPU temperature. This heat sensor generates an SMI (System Management Interrupt) when the CPU temperature is too hot. The SMI can be set to turn on the external cooling fan and/or lower the CPU clock frequency. You are warned that the CPU is overheating. The CPU is returned to normal operating conditions when the CPU temperature returns to normal. This feature can only be implemented if a power supply with a soft-off power controller is installed in the computer. See *the American Megatrends DMI Wizard 95 User's Guide* for additional information about this feature.

SDRAM The Apollo IV motherboard provides two 168-pin DIMM system memory sockets that support SDRAM (Synchronous Dynamic Random Access Memory). SDRAM increases the CPU-to-memory data transfer rate to 528 MBs. This rate is normally 264 MBs if EDO DRAM is installed. The integrated I2C controller optimizes the memory timing parameters.

System Memory The motherboard supports up to 256 MB of system memory mounted on the motherboard as follows:

Type of System Memory Socket	Type of System Memory	Supported System Memory
four 72-pin SIMM sockets	Fast Page Mode or EDO DRAM	8 MB, 16 MB, 32 MB, 64 MB, or 128 MB
two 168-pin DIMM sockets	EDO DRAM or SDRAM	8 MB, 16 MB, 32 MB, 64 MB, or 128 MB

Cont'd

PC 97 Compliant The Apollo IV motherboard is fully compliant with the Microsoft PC 97 specification at both the hardware and the BIOS levels.

PC 97 is a set of hardware, bus, and device design requirements specified by Microsoft that make computers easier to use. PC 97 supports cooperation between the operating system, the hardware, and the applications software. Key PC 97 features include:

- Plug and Play compatibility,
 - power management support for configuring and managing all system components
 - 32-bit device drivers, and
 - standard installation procedures for Microsoft Windows 95 and Windows NT.
-

AMIBIOS Features This motherboard has an AMIBIOS system BIOS on a Flash ROM with built-in AMIBIOS Setup. AMIBIOS features include:

- IDE block mode and 32-bit data transfer support,
 - IDE Programmed I/O modes 0, 1, 2, 3, and 4 support,
 - PS/2 mouse support,
 - IDE LBA mode support,
 - APM (Advanced Power Management) and Flash BIOS hooks,
 - EPA Green PC-compliant,
 - PCI and Plug and Play (PnP) support, and
 - DIM (Device Initialization Manager) support,
 - DMI (Desktop Management Interface) support,
 - can boot from a CD-ROM drive,
 - automatically detects system memory, cache memory, and hard disk drive parameters,
 - Intel NSP-compliant,
 - Fast ATA IDE mode programming and ATAPI support,
 - Boot sector virus protection,
 - instant-on support,
 - automatically configures PnP and PCI devices.
-

Cont'd

Overview, Continued

BIOS Shadowing	The system BIOS is always copied from ROM to RAM for faster execution. The end user can shadow 16 KB ROM segments from C0000h – DCFFFh.
IDE	The Apollo IV motherboard has two 40-pin IDE connectors onboard that support up to four IDE drives (hard disk drives, CD-ROM drives, or tape drives). The integrated PCI bus master enhanced IDE controller is on the PCI local bus. The IDE controller supports the Ultra DMA/33 protocol, which doubles the hard disk drive data transfer rates specified in the ATA-2 standards to 33 MBs while maintaining full backward compatibility with existing PIO mode 3, PIO mode 4, and DMA mode 2 devices.
Fast ATA	The motherboard supports the Fast ATA specification using PIO mode 4 and multiword DMA mode 2.
Ultra DMA/33	This motherboard includes an integrated enhanced IDE PCI bus master IDE controller that supports the Ultra DMA/33 protocol. The Ultra DMA/33 protocol permits data transfer rates up to 33 MBs. Ultra DMA/33 also reduces the CPU workload and permits increased CPU utilization. Ultra DMA/33 is completely backward-compatible with older DMA standards.
Floppy	The Apollo IV motherboard has an onboard floppy controller that supports up to two 360 KB, 720 KB, 1.2 MB, 1.44 MB, or 2.88 MB floppy drives.
Parallel Port	The Apollo IV motherboard has an onboard ECP and EPP-capable parallel port connector.
Serial Ports	The Apollo IV motherboard has two onboard serial port connectors and two 16550 UART serial ports.
Keyboard	The Apollo IV motherboard Includes a standard DIN keyboard connector.

Cont'd

Overview, Continued

Mouse The Apollo IV motherboard includes a 5-pin berg mouse connector.

USB The Apollo IV motherboard has two 4-pin USB connectors. USB allows future generations of USB-compliant peripheral devices to be automatically detected and configured through a single port. USB uses Plug and Play technology. All USB peripherals are automatically detected and configured. The AMIBIOS on this motherboard provides complete USB system BIOS support.

Power Connectors The Apollo IV motherboard has three power supply connectors.

RTC/CMOS RAM A real time clock and 128 bytes of CMOS RAM with a battery backup is provided on the motherboard.

Power Management Power management services include:

- Green PC LED,
 - power management signal to Green PC-aware power supplies,
 - automatic IDE and video power down,
 - monitor blanking,
 - SMI (System Management Interrupt) support,
 - APM, and
 - system stop clock.
-

PCI Slots The motherboard conforms to the PCI Version 2.1 specification. The concurrent PCI architecture of this motherboard allows faster CPU, PCI, and ISA bus transactions for faster and smoother multimedia performance. This motherboard allows you to install either PCI V2.0 or PCI V2.1-compatible adapter cards

The PCI slots are automatically configured by the AMIBIOS. The PCI slots operate synchronously with the CPU clock, as follows:

CPU External Clock Frequency	PCI Expansion Slot Frequency
66 MHz	33 MHz
60 MHz	30 MHz

Onboard I/O The Apollo IV Pentium ISA motherboard includes:

- two 40-pin IDE connectors on the PCI bus that support up to four IDE drives,
 - a 34-pin floppy drive connector,
 - two 10-pin serial port connectors (with 16550 UARTs),
 - a 26-pin parallel port connector with ECP and EPP support,
 - an infrared connector,
 - two USB connectors that support an optional riser card that permit high speed Plug and Play connection to USB-compliant external peripheral devices,
 - a keyboard connector, and
 - a PS/2 mouse connector.
-

Cont'd

DMI

In a corporate environment, system manageability is an important consideration. DMI (Desktop Management Interface) is a specification for a standard method of storing and reporting system information. This motherboard supports the DMI specification on the system BIOS level. DMI detects and records system configuration information, including the CPU type and speed, memory size and type, and much more information. DMI maintains a local database of system configuration information that can be accessed and even modified from a remote location.

The American Megatrends DMI Wizard 95 is also shipped with this motherboard. Use DMI Wizard 95 to display and modify DMI information. DMI Wizard 95 allows a system integrator or user to add additional information to the DMI database, such as serial numbers and chassis information. See *the American Megatrends DMI Wizard 95 User's Guide* for additional information.

Infrared

This motherboard includes a 10-pin serial infrared connector. Infrared allows bidirectional cordless data transactions with other IrDA-compliant computers and peripheral devices. Infrared transmissions can occur in half-duplex (sequential transmission/receiving) or full-duplex (simultaneous transmission) modes.

A 10-pin infrared connector is provided on the motherboard. The motherboard and AMIBIOS comply with the IrDA SIR infrared device standards and specifications.

This motherboard complies fully with the IrDA infrared standards. An IrDA-compliant device can be installed via a 9-pin D-type connector on the rear of the computer. The 9-pin connector is attached by a cable to the IR berg connector on the motherboard, next to the serial connectors (COM1 and COM2). COM2 on the motherboard is an IrDA-compliant port. You must set the Serial Port2 Mode, IR Transmission Type, and other AMIBIOS Setup options under Peripheral Setup before you can use an infrared device.

Apollo IV Dimensions

Motherboard Size The Apollo IV Pentium PCI ISA motherboard is the standard baby AT size (11" by 8.6").

Motherboard Height Restrictions

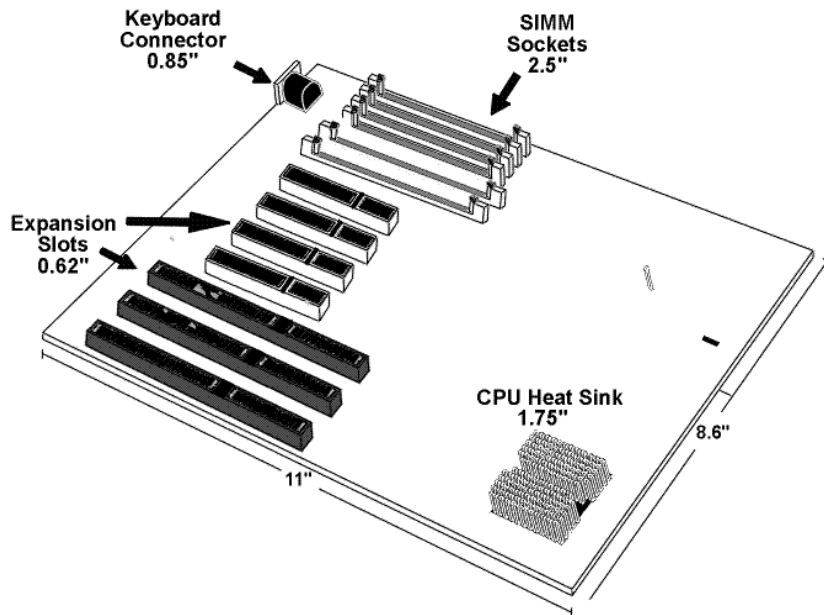

Installation Steps

Step	Action
1	Unpack the motherboard.
2	Set Jumpers
3	Configure the CPU. Select the CPU voltage. Select the CPU speed. Install the CPU.
4	Install memory. Install system memory.
5	Install the motherboard.
6	Attach cables to connectors. Connect the power supply. Attach the keyboard cable. Connect the mouse cable. Attach cables.
7	Connect onboard I/O. Connect the serial ports. Connect the parallel port.
8	Connect floppy drive(s).
9	Connect the IDE drive(s).
10	Test and configure.

Warning

This motherboard contains sensitive electronic components that can be easily damaged by static electricity. Follow the instructions carefully to ensure correct installation and to avoid static damage.

Apollo IV Motherboard Layout

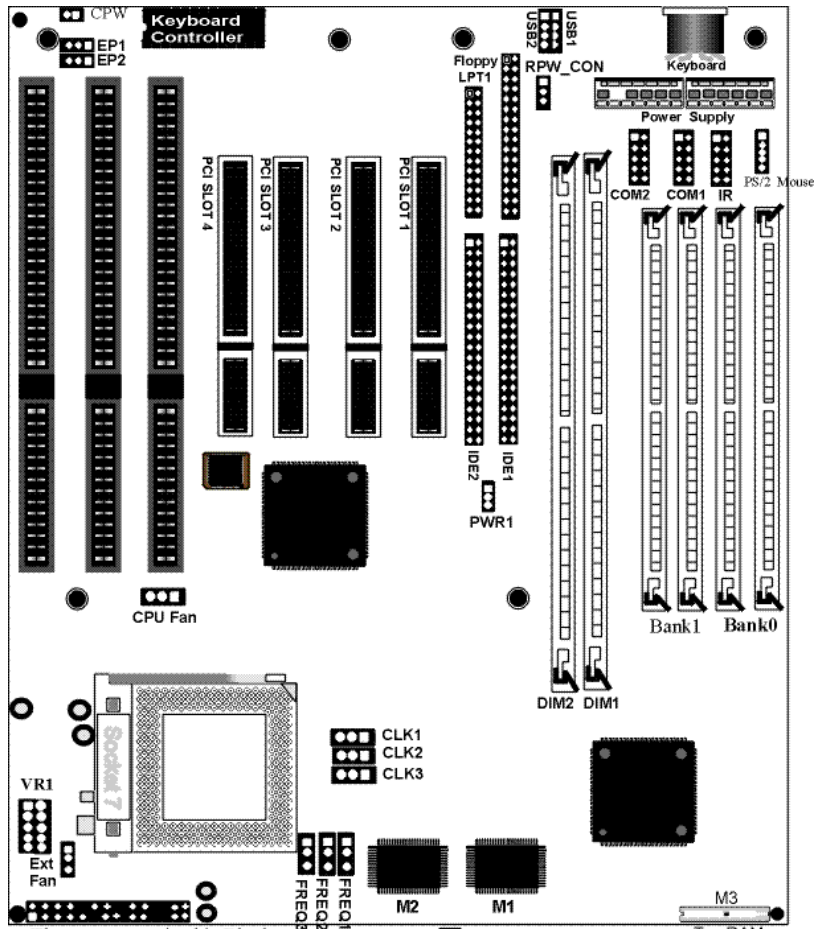

The connectors in this Block Header are detailed below:

A Square Pad identifies Pin 1 in Jumpers and Connectors.

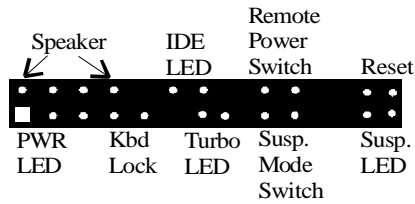

Step 1 Unpack the Motherboard

Step	Action
1	Inspect the cardboard carton for obvious damage. If damaged, call 770-246-8645. Leave the motherboard in its original packing.
2	Perform all unpacking and installation procedures on a ground-connected anti-static mat. Wear an anti-static wristband grounded at the same point as the anti-static mat. Or use a sheet of conductive aluminum foil grounded through a 1 megohm resistor instead of the anti-static mat. Similarly, a strip of conductive aluminum foil wrapped around the wrist and grounded through a 1 megohm resistor serves the same purpose as the wristband.
3	Inside the carton, the motherboard is packed in an anti-static bag, and sandwiched between sheets of sponge. Remove the sponge and the anti-static bag. Place the motherboard on a grounded anti-static surface component side up. Save the original packing material.
4	Inspect the motherboard for damage. Press down on all ICs mounted in sockets to verify proper seating. Do not apply power to the motherboard if it has been damaged.
5	If the motherboard is undamaged, it is ready to be installed.

Step 2 Set Jumpers

Set all jumpers and install the CPU before placing the motherboard in the chassis. Set jumpers by placing a shunt (shorting bridge) on the designated pins of the jumper. A shunt and jumpers are shown below:

3-dimensional view of motherboard jumpers and a shunt.

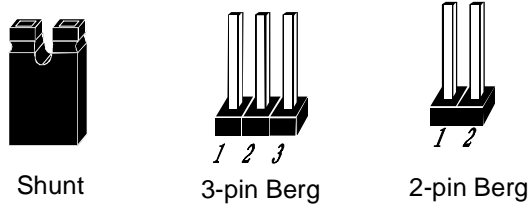

In this manual, jumpers are shown in two -dimensions, as if viewed from directly above, as shown below:

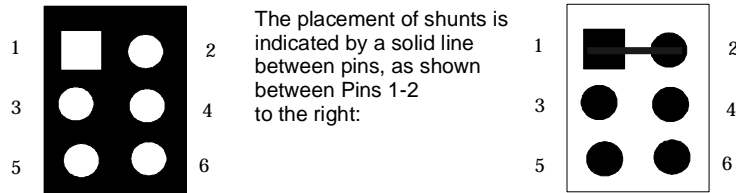

PWR1 Power Supply Type PWR1 is a 3-pin berg that sets the power supply type:

PWR1 Setting	Description
Short Pins 1-2	AT-type power supply is installed (factory setting).
Short Pins 2-3	Remote power supply is used.

CPW Clear Password CPW is a 2-pin berg that allows you to delete the system BIOS password should you forget the password. CPW should be OPEN at all times during normal operation. Should you forget the password: turn power off, remove the computer cover, turn power on, place a shorting bridge (shunt) on CPW for a few seconds, then turn power off again. Reboot the computer and re-enter all system configuration information, because you have just erased all of it.

Cont'd

Step 2 Set Jumpers, Continued

EP1, EP2 Flash ROM Type EP1 and EP2 are 3-pin bergs that specify the type of flash ROM installed on the motherboard. The settings are:

Flash ROM Type	EP1	EP2
Intel 28F001	Short Pins 2-3	Short Pins 1-2
SST 29EE010	OPEN	Short Pins 2-3
MXIC MX28F2000	Short Pins 2-3	Short Pins 2-3
SST 29EE020	OPEN	Short Pins 2-3
ATMEL AT29C020	OPEN	Short Pins 2-3
AMD 28F020	Short Pins 1-2	Short Pins 2-3

Avoid Static Electricity

Static electricity can damage the motherboard and other computer components. Keep the motherboard in the anti-static bag until it is to be installed. Wear an anti-static wrist grounding strap before handling the motherboard. Make sure you stand on an anti-static mat when handling the motherboard.

Avoid contact with any component or connector on any adapter card, printed circuit board, or memory module. Handle these components by the mounting bracket.

Step 3 Configure CPU

Important

Perform the following steps to configure the motherboard before installing a CPU.

External CPU Clock CLK1, CLK2, and CLK3 are 3-pin bergs that set the CPU external clock frequency. This motherboard may have any of four different clock generators:

- IMI652,
- ICS 9147,
- ICW, or
- PhaseLink.

The CLK1, CLK2, and CLK3 settings are different with the different clock generators. You must determine the clock generator type (it's next to the CPU) before setting these jumpers.

IMI 652 Clock Generator The following CLK1, CLK2, and CLK3 settings apply only if an IMI 652 clock generator is mounted on the motherboard.

External (CPUCLK)	CLK1	CLK2	FREQ1
66 MHz	Short Pins 1-2	Short Pins 1-2	Short Pins 2-3
60 MHz	Short Pins 2-3	Short Pins 1-2	Short Pins 2-3
55 MHz	Short Pins 2-3	Short Pins 2-3	Short Pins 2-3
50 MHz	N/A	N/A	N/A

Cont'd

Step 3 Configure CPU, Continued

ICS 9147 Clock Generator The following CLK1, CLK2, and CLK3 settings apply only if an ICS 9147 clock generator is mounted on the motherboard.

External (CPUCLK)	CLK1	CLK2	FREQ1
66.6 MHz	Short Pins 1-2	Short Pins 2-3	Short Pins 2-3
60 MHz	Short Pins 2-3	Short Pins 2-3	Short Pins 2-3
55 MHz	Short Pins 1-2	Short Pins 1-2	Short Pins 2-3
50 MHz	Short Pins 2-3	Short Pins 1-2	Short Pins 2-3

ICW or PhaseLink Clock Generator The following CLK1, CLK2, and CLK3 settings apply only if an ICW or PhaseLink clock generator is mounted on the motherboard.

External (CPUCLK)	CLK1	CLK2	FREQ1
66.6 MHz	Short Pins 1-2	Short Pins 1-2	Short Pins 1-2
60 MHz	Short Pins 2-3	Short Pins 1-2	Short Pins 1-2
55 MHz	Short Pins 2-3	Short Pins 2-3	Short Pins 1-2
50 MHz	N/A	N/A	N/A

CPU/Bus Frequency Ratio FREQ1, FREQ2, and FREQ3 are 3-pin bergs that set the ratio of the internal CPU frequency to the bus clock.

For P54C	For P55C, and K6	For K5	FREQ1	FREQ2	FREQ3
3x	3x	2x	Short Pins 1-2	Short Pins 2-3	Short Pins 1-2
2.5x	2.5x	1.75x	Short Pins 2-3	Short Pins 2-3	Short Pins 1-2
2x	2x	N/A	Short Pins 2-3	Short Pins 1-2	Short Pins 1-2
1.5x	3.5x	1.5x	Short Pins 1-2	Short Pins 1-2	Short Pins 1-2

Cont'd

Step 3 Configure CPU, Continued

Summary of Jumper Setting for Intel Pentium CPUs

Speed	Multi plier	Ext. Speed	IMI 652 Clock Generator			OCS 9147 Clock Generator			FREQ1	FREQ 2	FRE Q3
			CLK1	CLK2	CLK3	CLK1	CLK2	CLK3			
P55C											
233	3.5x	66									
200	3x	66									
166	2.5x	66									
P54C											
200	3x	66									
166	2.5x	66									
150	2.5x	60									
133	2x	66									
120	2x	60									
100	1.5x	66									
90	1.5x	60									

Cont'd

Step 3 Configure CPU, Continued

Summary of Jumper Setting for AMD K5 and K6 CPUs

Speed	Multi-plier	Ext. Speed	IMI 652 Clock Generator			OCS 9147 Clock Generator			FREQ1	FREQ2	FREQ3
			CLK1	CLK2	CLK3	CLK1	CLK2	CLK3			
K6-233											
233	3.5x	66									
K6-200											
200	3x	66									
K6-166											
166	2.5x	66									
K5-PR200											
200	2x	66									
K5-PR166											
166	1.75x	66									
K5-PR150											
150	1.75x	60									
K5-PR133											
133	1.5x	66									
K5-PR120											
120	1.5x	60									
K5-PR100											
100	1.5x	66									
K5-PR90											
90	1.5x	60									

Cont'd

Step 3 Configure CPU, Continued

VR Set Pentium CPU Voltage Install Intel Pentium CPUs that adhere to either the standard or VRE voltage specifications. VR is a 10-pin berg that sets CPU voltage. VR1 is near the top of the CPU socket.

Core: 3.5V
I/O: Same
P54C VRE

Core: 3.3V
I/O: Same
P54C Standard

Core: 2.8V
I/O: 3.3V
P55C

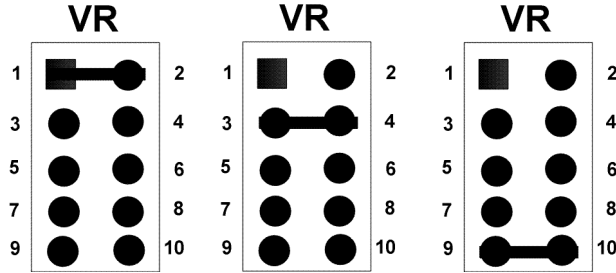

Intel Pentium CPU Markings The markings on the bottom side of the Intel Pentium CPUs are:

```

XXXXXXXXXX
XXXXXXXXXX
BP80502-SSS
Sxxxx/RSS
xxx

```

R is the voltage range identifier:

R value	Description
V	VRE voltage range
S	Standard voltage range

Cont'd

Step 3 Configure CPU, Continued

Set AMD CPU Voltage Install AMD K5 and K6 CPUs that adhere to either the standard or VRE voltage specifications. VR is a 10-pin berg that sets CPU voltage. VR1 is near the top of the CPU socket.

Core: 3.5V	Core: 3.2V	Core: 2.9V
I/O: 3.5V	I/O: 3.3V	I/O: 3.3V
AMD K5-B	233 MHz AMD K6	166 and 200 MHz AMD K6

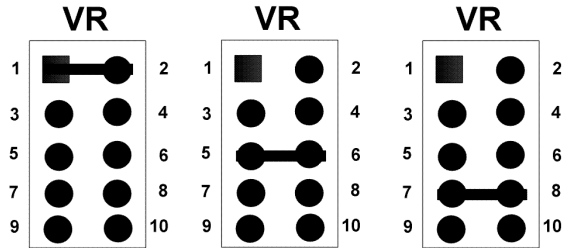

AMD K5 CPU Markings The markings on the top of the AMD K5 CPUs are:

AMD-K5
 AMD-K5-PRxxxABQ
 where B is the voltage range identifier.

AMD K6 CPU Markings The markings on the top of the AMD K6 CPUs are:

AMD-K6

AMD-K6-xxxA AMD K5 CPU Markings The markings on the top of the AMD K5 CPUs are:

AMD-K5
 AMD-K5_PRxxxAVQ
 where V is the voltage range identifier.

B and V value	Description
N	Core 3.1 – 3.3V I/O 3.135 – 3.6V
L	Core 2.755 – 3.045V I/O 3.135 – 3.6V

Cont'd

Step 3 Configure CPU, Continued

Install CPU Install the CPU in the ZIF (zero insertion force) socket by performing the following steps. The CPU socket is near one edge of the motherboard.

Warning

Improper CPU installation can damage the CPU and the motherboard. You must follow the procedures in this section exactly as documented. Make sure you wear an antistatic wristband while installing the CPU. Follow all antistatic procedures.

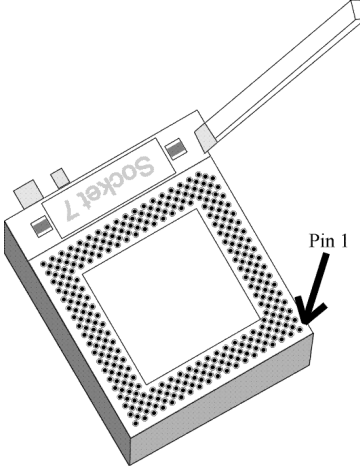
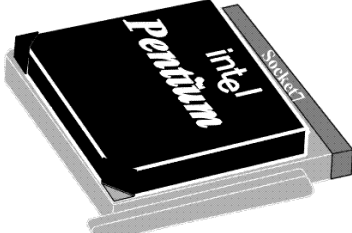
Step	Action
1	<p>Lift the lever on the ZIF socket. The empty CPU socket looks like this.</p> 
2	<p>Check for bent pins on the CPU. Gently straighten any bent pins with pliers. Place the CPU in the middle of the socket. Make sure that pin 1 of the CPU is aligned with pin 1 of the socket. <i>Make sure you are properly grounded while handling the CPU.</i></p>
3	<p>Complete installation by lifting the ZIF lever to the other side of the socket, as shown below.</p> 

Step 4 Install Memory

System Memory The motherboard has four 72-pin SIMM – Single Inline Memory Module) sockets and two 168-pin DIMM sockets. Memory must be populated one bank at a time. Each bank has two sockets. Each bank must be populated with the same type of SIMM. If a 16 MB SIMM is installed in the first socket in Bank0, then the same type of 16 MB SIMM must be installed in the second Bank0 SIMM socket.

The motherboard supports up to 256 MB of system memory mounted on the motherboard as follows:

Type of System Memory Socket	Type of System Memory	Supported System Memory
four 72-pin SIMM sockets	Fast Page Mode or EDO DRAM	8 MB, 16 MB, 32 MB, 64 MB, or 128 MB
two 168-pin DIMM sockets	EDO DRAM or SDRAM	8 MB, 16 MB, 32 MB, 64 MB, or 128 MB

Supported System Memory Configurations

SIMM Bank0	SIMM Bank1	DIMM1	DIMM2	Total System Memory
4 MB and 4 MB				8 MB
		8 MB		8 MB
8 MB and 8 MB				16 MB
		16 MB		16 MB
16 MB and 16 MB				32 MB
		32 MB		32 MB
32 MB and 32 MB				64 MB
		64 MB		64 MB
64 MB and 64 MB				128 MB
		64 MB	64 MB	128 MB
64 MB and 64 MB	64 MB and 64 MB			256 MB

Cont'd

Step 4 Install Memory, Continued

Installing SIMMs The motherboard has four x 36 SIMM sockets. These sockets can be filled with either 1 MB x 36, 4 MB x 36, 8 MB x 36, or 16 MB x 36 SIMMs.

Place the motherboard on an anti-static mat. With the component side of the SIMM facing you, firmly push the SIMM into the socket at an angle, then push it up. When properly inserted, the SIMM clicks into place as the latching pins engage.

Memory Display System memory is reported by AMIBIOS as it boots and again when the AMIBIOS System Configuration Screen is displayed just before the operating system boots. The memory displayed by AMIBIOS on the System Configuration Screen is 384 KB less than the total memory installed.

Step 5 Install the Motherboard

The motherboard mounting hole pattern is the same as the mounting hole pattern on the standard baby AT motherboard. Standoffs and mounting screws are not supplied with the motherboard. The chassis manufacturer should supply these parts.

Step	Action
1	Place the chassis on an anti-static mat. Connect the chassis to ground to avoid static damage during installation. Connect an alligator clip with a wire lead to any unpainted part of the chassis. Ground the other end of the lead at the same point as the mat and the wristband.
2	Rotate the chassis so the front is to the right, and the rear is to the left. The side facing you is where the motherboard is mounted. The power supply is mounted at the far end of the chassis.
3	Hold the motherboard, component-side up, with the edge with the SIMM sockets toward you and the edge with the power supply connector away from you. The keyboard, mouse, and video connectors should be to the left.
4	Carefully slide the motherboard into the chassis. Make certain the edge connectors fit the ports in the rear of the chassis. The motherboard should rest level with the chassis.
5	Place the mounting screws in the holes provided and tighten them. If necessary, shift the motherboard slightly to align the mounting holes on the motherboard with the holes on the chassis. See the drawing on the next screen.

Warning

If using metallic screws, make sure you use them only in the plated mounting holes.

If using metallic screws, make sure the head of the screw fits completely inside the plated mounting holes.

See the graphic on the following screen.

Cont'd

Step 5 Install Motherboard, Continued

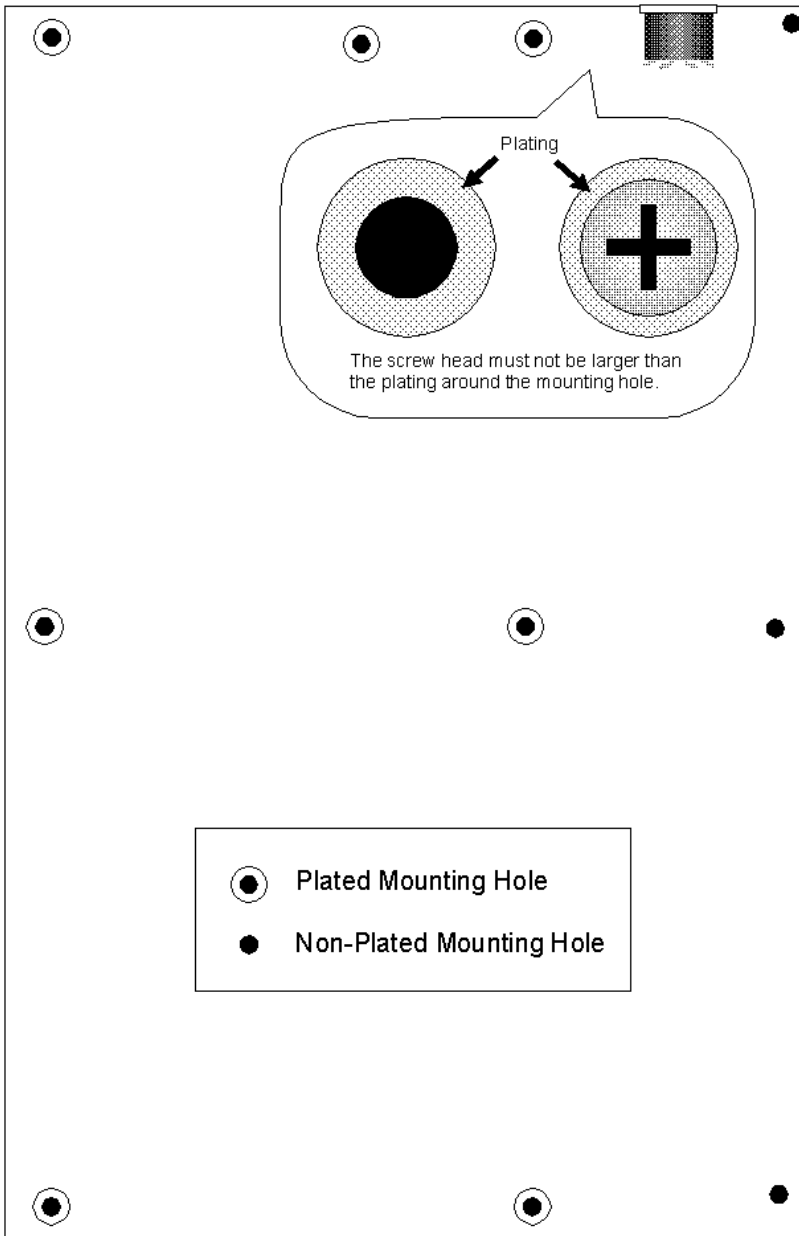

Step 6 Attach Cables

Connectors The Apollo IV motherboard includes many connectors. Connection instructions, illustrations of connectors, and pinouts are:

Connector
Power supply connector
Keyboard connector
Mouse connector
CPU Fan
Chassis Fan
Infrared
Remote Power connector
USB connectors
Speaker
IDE LED
Remote Power Switch
Hardware Reset Switch
Power LED (lit when power is on)
Keyboard Lock
Turbo LED (lit when high speed is active)
Suspend Mode Switch
Suspend LED (lit when system in suspend mode)
Serial Port
Parallel port
Floppy drive connector
IDE drive connectors

Cable Connector Ends When connecting chassis connectors to the motherboard, make sure to connect the correct connector end. Most connector wires are color-coded. Match the color of the wires leaving the switch or LED to the same pin on the connector end. There may be more than one connector with the same color-coded wires. If so, follow the wire to the switch or LED. Pin 1 is indicated by a white line. Pin 1 is always nearest the white line.

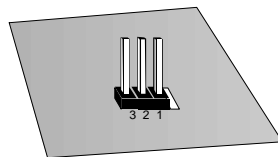

Cont'd

Step 6 Attach Cables, Continued

Connect Power Supply The power supply should match the physical configuration of the chassis. Make sure that the power switch is Off before assembly.

Before attaching all components, make sure that the proper voltage has been selected. Power supplies often can run on a wide range of voltages and must be set (usually via a switch) to the proper range. Use at least a 300 watt power supply, which should have built-in filters to suppress radiated emissions.

Power Cables Attach the power supply cables to the power connector on the motherboard. AT-compatible power supplies have one twelve pin connector, as shown below.

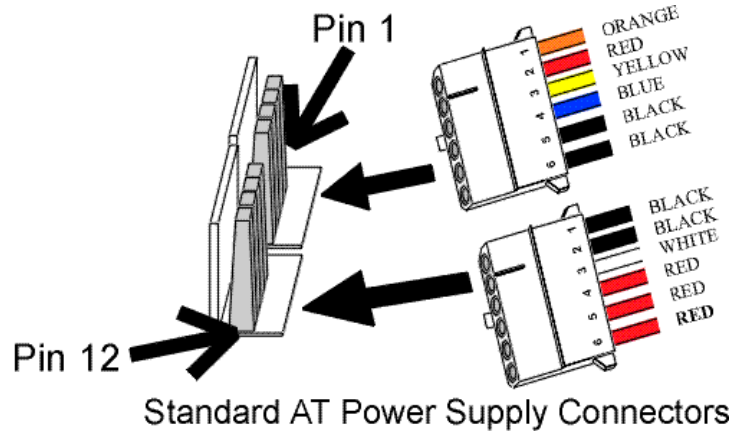

Cont'd

Step 6 Attach Cables, Continued

Connector Keys The keys on the connector must be cut to fit on some power supplies, as shown below.

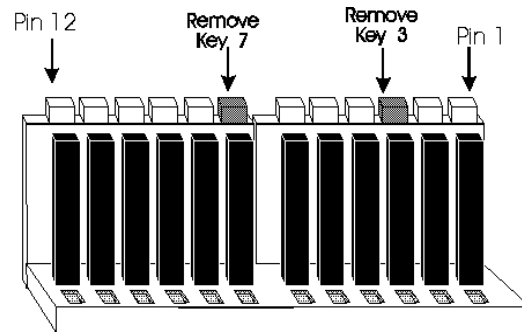

Power Connector Pinout

Pin	Description
1	Power Good (Orange wire) (Not used)
2	VCC (Red wire)
3	+12 Volts (Yellow wire)
4	-12 Volts (Blue wire)
5	Ground (Black wire)
6	Ground (Black wire)
7	Ground (Black wire)
8	Ground (Black wire)
9	-5 Volts (White wire)
10	VCC (Red wire)
11	VCC (Red wire)
12	VCC (Red wire)

Keyboard Cable The keyboard attaches via a PS/2 keyboard connector, labeled AT_KB.

Pin	Signal Description
1	Keyboard data
2	N/C
3	Ground
4	VCC
5	Keyboard clock
6	N/C

Cont'd

Step 6 Attach Cables, Continued

Mouse Cable Attach the mouse connector cable supplied by American Megatrends to the five-pin mouse berg connector on the motherboard (labeled MS_CON), as shown below. Attach the standard 9-pin mouse connector at the other end of the mouse cable to the mouse connector port on the computer case. Incorrect mouse installation can cause the system to hang.

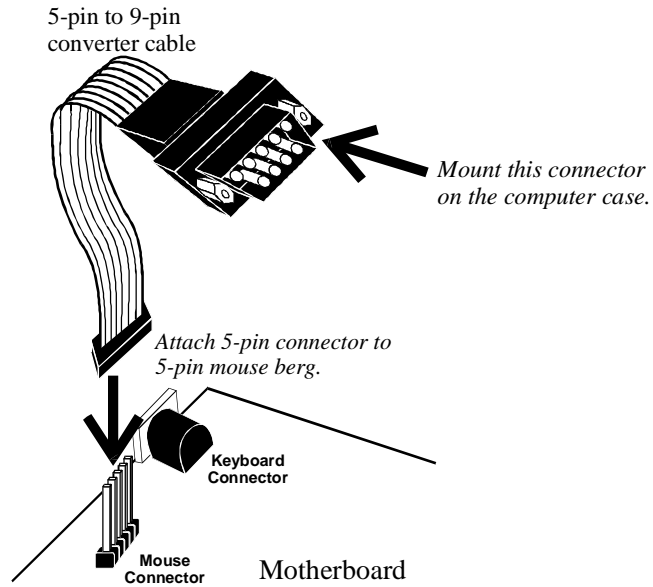

Pin	Description
1	Mouse Clock
2	N/C
3	N/C
4	Mouse Data
5	Ground

Cont'd

Step 6 Attach Cables, Continued

When connecting chassis connectors to the motherboard, make sure to connect the correct connector end. Most connector wires are color-coded. Match the color of the wires leaving the switch or LED to the same pin on the connector end. There may be more than one connector with the same color-coded wires. If so, follow the wire to the switch or LED. Pin 1 is always indicated on the motherboard.

CPU Fan A three-pin berg labeled FAN attaches to the CPU fan. The FAN connector is near the CPU end of the ISA expansion slots.

Pin	Description
1	Ground
2	+12V
3	Ground

Chassis Fan A three-pin berg labeled EXT_FAN attaches to the chassis cooling fan. The EXT_FAN connector is near the CPU.

Pin	Description
1	Ground
2	+12V
3	Ground

IR Infrared The 8-pin infrared connector (IR) next to the COM1 and COM2 connectors attaches to an infrared port mounted on the computer chassis. It allows data transmission to any other device that supports the IrDA standards for infrared transmission.

Remote Control Power RPW_COM is a 3-pin berg next to the USB connectors that attaches to the power supply for enabling system power when the remote power switch is turned on. Connect a 3-wire power cable to RPW_COM and attach the other end to the peripheral device.

USB Connectors The Apollo IV motherboard has two 4-pin headers (USB1 and USB2) that attach to a USB connector on the computer chassis. The USB port allows you to attach to a USB hub. The USB connector pinouts are the same for both USB connectors:

Pin	Signal Description
1	VCC (Fused 5V)
2	- Data
3	+ Data
4	Ground

Cont'd

Step 6 Attach Cables, Continued

Block Connector The Apollo IV motherboard has a 22-pin header that is used to connect the following offboard connectors. The header is on the corner of the motherboard near the CPU socket.

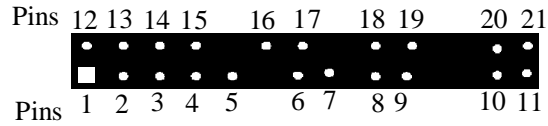

Connector	Signal Descriptions
Speaker	Pin 12 VCC Pin 13 Ground Pin 14 Ground Pin 15 Speaker Data
IDE LED	Pin 16 LED Power Pin 17 IDE Active
Remote Power Switch (Power when low).	Pin 18 Remote Power Pin 19 Ground
Hardware Reset Switch	Pin 20 Hard Reset Pin 21 Ground
Power LED (lit when power is on)	Pin 1 +Power Pin 2 Ground
Keyboard Lock	Pin 4 Keyboard Lock Pin 5 Ground
Turbo LED (lit when low speed is active)	Pin 6 TURBO_LIT Pin 7 TURBO_LEDPWR
Suspend Mode Switch (Suspend when Low)	Pin 8 Suspend In Switch Pin 9 Ground
Suspend LED (lit when system in suspend mode)	Pin 10 Suspend Out LED+ Pin 11 Suspend Out LED-

Step 7 Connect Onboard I/O

Onboard I/O The Apollo IV motherboard has:

- two serial ports (COM1 and COM2),
- a parallel port (LPT),
- an IDE controller on the PCI bus. The primary IDE connector is IDE1. The secondary connector is IDE2.
- a floppy controller (FDD).

The serial and parallel port connectors are described below.

Conflicts AMIBIOS minimizes conflicts between onboard and offboard I/O devices. AMIBIOS automatically checks the adapter cards installed in the expansion slots on the Apollo IV motherboard for a hard disk or floppy controller and serial or parallel ports.

Serial Ports COM1 and COM2 are 10-pin connectors that provide an AT-compatible serial port interface. Connect the cables supplied with the motherboard to the 10-pin serial connectors. The serial port base I/O port address and other serial port settings can be selected in Peripheral Setup in AMIBIOS Setup. The serial connector pinout is shown below. COM2 and IR use the same IRQ, so the COM2 connector does not work if an infrared device is attached to the IR connector.

Pin	Description	Pin	Signal Description
1	Carrier Detect	6	Data Set Ready
2	Receive Data	7	Request to Send
3	Transmit Data	8	Clear to Send
4	Data Terminal Ready	9	Ring Indicator
5	Ground	10	CUT PIN

Cont'd

Step 7 Connect Onboard I/O, Continued

Parallel Port PRINTER is a 26-pin connector for a parallel port. The LPT pinout is shown below. Connect the 26-pin to DB25 cable provided with the motherboard to PRINTER. All parallel port settings can be configured through Peripheral Setup in WINBIOS Setup.

Pin	Signal Description	Pin	Signal Description
1	STROBE#	2	PD0
3	PD1	4	PD2
5	PD3	6	PD4
7	PD5	8	PD6
9	PD7	10	ACK#
11	BUSY	12	PE
13	SLCT	14	AUTOFD#
15	ERROR#	16	INIT#
17	SLCTIN#	18	Ground
19	Ground	20	Ground
21	Ground	22	Ground
23	Ground	24	Ground
25	Ground	26	Ground

Step 8 Attach Floppy Drive

FLOPPY

FLOPPY is a 34-pin dual-inline berg. Connect the cable from the floppy drive to FLOPPY, as shown below. The onboard floppy controller cannot be used if a hard disk card with a floppy controller is installed. Choose Standard Setup and Peripheral Setup to configure the floppy controller.

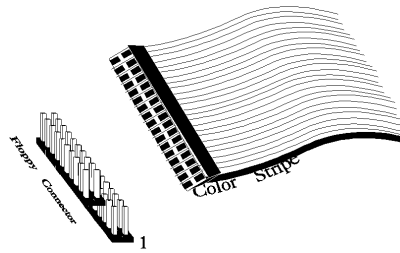

The motherboard supports up to two 720 KB, 1.44 MB, or 2.88 MB 3½" drives and 360 KB and 1.2 MB 5¼" drives. The connecting cable is a 34-pin ribbon connector with two 34-pin edge connectors for attaching the floppy disk drives. There is a small twist in the cable between the floppy connectors. The last (end) connector should be connected to floppy drive A:.

Cont'd

Step 8 Attach Floppy Drive, Continued

Floppy Connector Pinout

Pin	Use	Pin	Use
1	GND	2	DENSE1
3	GND	4	N/C
5	GND	6	DRATE0
7	GND	8	-INDEX
9	GND	10	-MOTOR0
11	GND	12	-FDSEL1
13	GND	14	-FDSEL0
15	GND	16	-MOTOR1
17	GND	18	DIR
19	GND	20	-
21	GND	22	-WDATA
23	GND	24	-WGATE
25	GND	26	-TRK0
27	GND	28	-WRPROT
29	GND	30	-RDATA
31	GND	32	HDSEL
33	GND	34	DSKCHNG

Twist in Floppy Cable

Floppy B to A	Floppy B to A	Floppy B to A	Floppy B to A
10 to 16	12 to 14	14 to 12	16 to 10
11 to 15	13 to 13	15 to 11	

Step 9 Attach IDE Drive

IDE Drives Attach the IDE drives in the following manner. Choose Peripheral Setup in WINBIOS Setup to enable the onboard IDE controller.

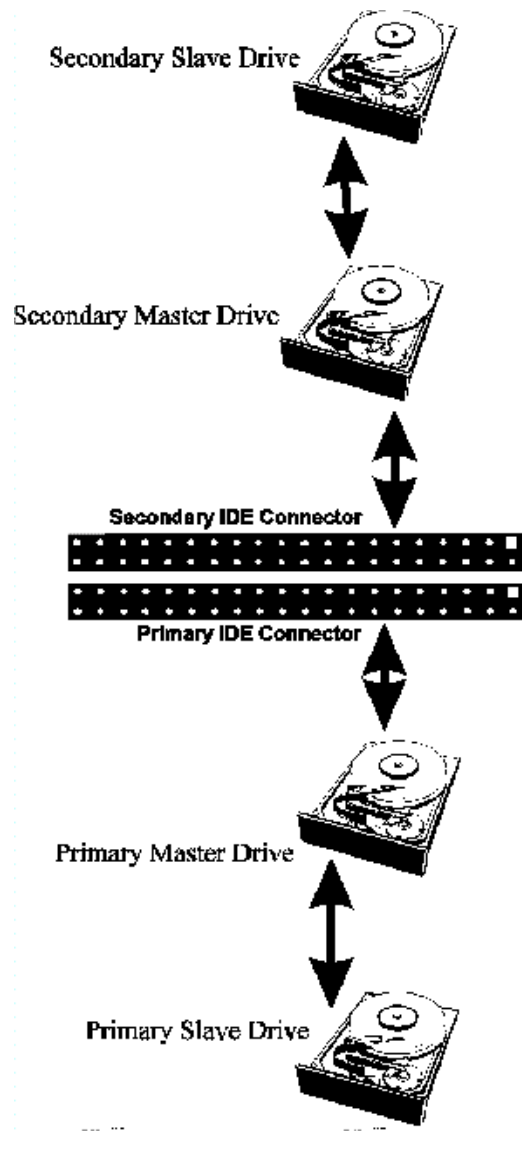

Cont'd

Step 9 Attach IDE Drive, Continued

Attach IDE Cable The primary IDE (Integrated Drive Electronics) hard disk drive connector is marked PRIMARY. Both the primary master and the primary slave IDE drives must be connected by cable to PRIMARY, as shown below.

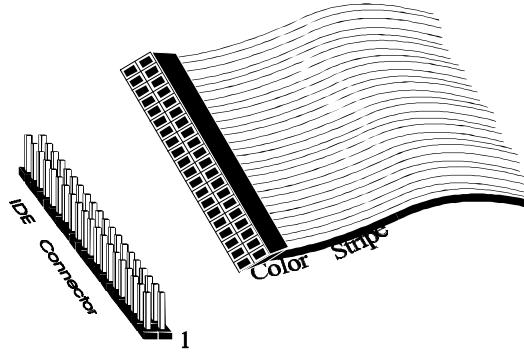

PRIMARY is a 40-pin dual-inline berg that connects an IDE drive to the primary onboard IDE connector. This motherboard supports IDE Modes 0, 1, 2, 3, and 4, IDE prefetch, LBA (Logical Block Address) mode, high capacity drives (over 528 MB), 32-bit data transfer, and fast IDE transfer. These IDE features are configured in Peripheral Setup in the WINBIOS Setup utility. Disable the onboard IDE interface in Peripheral Setup to use an ISA ESDI, RLL, MFM, or SCSI hard disk drive controller.

Cont'd

Step 9 Attach IDE Drive, Continued

PRIMARY Pinout The PRIMARY IDE pinout is:

Pin	Use	Pin	Use
1	-RESET	2	GND
3	DATA7	4	DATA8
5	DATA6	6	DATA9
7	DATA5	8	DATA10
9	DATA4	10	DATA11
11	DATA3	12	DATA12
13	DATA2	14	DATA13
15	DATA1	16	DATA14
17	DATA0	18	DATA15
19	GND	20	KEY (N/C)
21	N/C	22	GND
23	-IOW	24	GND
25	-IOR	26	GND
27	IDERDY	28	ALE
29	N/C	30	GND
31	INT14	32	-IOCS16
33	HA1	34	N/C
35	HA0	36	HA2
37	-CS0	38	-CS1
39	-IDEACT	40	GND

Secondary IDE Controller The secondary IDE connector is labeled SECONDARY. It connects the secondary primary and slave IDE drives to the secondary onboard IDE controller.

Attach the secondary master and slave IDE drives to IDE2 via a standard 40-pin IDE cable.

Cont'd

Step 9 Attach IDE Drive, Continued

SECONDARY IDE Pinout The SECONDARY pinout is:

Pin	Use	Pin	Use
1	-RESET	2	GND
3	DATA7	4	DATA8
5	DATA6	6	DATA9
7	DATA5	8	DATA10
9	DATA4	10	DATA11
11	DATA3	12	DATA12
13	DATA2	14	DATA13
15	DATA1	16	DATA14
17	DATA0	18	DATA15
19	GND	20	KEY (N/C)
21	N/C	22	GND
23	-IOW	24	GND
25	-IOR	26	GND
27	IDERDY	28	ALE
29	N/C	30	GND
31	INT15	32	-IOCS16
33	HA1	34	N/C
35	HA0	36	HA2
37	-CS2	38	-CS3
39	N/C	40	GND

Step 10 Test and Configure

Review the following points before powering up:

- make sure that all adapter cards are seated properly,
 - make sure all connectors are properly installed,
 - make sure the CPU is seated properly,
 - make sure there are no screws or other foreign material on the motherboard,
 - plug the system into a surge-protected power strip, and
 - make sure blank back panels are installed on the back of the chassis to minimize RF emissions.
-

Start the Test Plug everything in and turn on the switch. If there are any signs of a problem, turn off the unit immediately. Reinstall the connectors. Call Technical Support if there are problems.

BIOS Errors If the system operates normally, a display should appear on the monitor. The BIOS Power On Self Test (POST) should execute.

If POST does not run successfully, it will beep or display error messages. Beeps indicate a serious problem with the system configuration or hardware. The Beep Code indicates the problem. AMIBIOS Beep Codes are defined in *the AMIBIOS Technical Reference*. Make sure the affected part is properly seated and connected. An error message is displayed if the error is less serious. Recheck the system configuration or the connections.

Configure the System Run WINBIOS Setup. You must enter the requested information and save the configuration data in CMOS RAM. The system will then reset, run POST, and boot the operating system. See the following chapter for information about configuring the computer.

2 WINBIOS® Setup

In ISA and EISA computers, the system parameters (such as amount of memory, type of disk drives and video displays, and many other elements) are stored in CMOS RAM. Unlike the DRAM (dynamic random access memory) that is used for standard system memory, CMOS RAM requires very little power. When the computer is turned off, a back-up battery provides power to CMOS RAM, which retains the system parameters. Every time the computer is powered-on, the computer is configured with the values stored in CMOS RAM by the system BIOS, which gains control when the computer is powered on.

The system parameters are configured by a system BIOS Setup utility. Historically, BIOS Setup utilities have been character-based, required keyboard input, and have had user interfaces that were not very intuitive.

Graphical Interface American Megatrends has a new type of system BIOS Setup utility. WINBIOS Setup has a graphical user interface the end user can access using a mouse. The WINBIOS Setup code is so compact that it can reside on the same ROM as the system BIOS. The system configuration parameters are set by WINBIOS Setup.

Since WINBIOS Setup resides in the ROM BIOS, it is available each time the computer is turned on.

Starting WINBIOS Setup As POST executes, the following appears:

```
Hit <DEL> if you want to run SETUP
```

```
Press <Del> to run WINBIOS Setup.
```

Using a Mouse with WINBIOS Setup

WINBIOS Setup has a built-in mouse driver and can be accessed by either a serial mouse or PS/2-style mouse. WINBIOS Setup supports Microsoft-Compatible serial mice and all PS/2-type mice.

The mouse click functions are: single click to change or select both global and current fields and double click to perform an operation in the selected field.

Using the Keyboard with WINBIOS Setup

WINBIOS has a built-in keyboard driver that uses simple keystroke combinations:

Keystroke	Action
<Tab>	Change or select a global field.
<→, ←, ↑, ↓>	Change or select the current field.
<Enter>	Perform an operation in the current field.
+	Increment a value.
-	Decrement a value.
<Esc>	Abort any window function.
<PgUp>	Return to the previous screen.
<PgDn>	Advance to the next screen.
<Home>	Returns to the beginning of the text.
<End>	Advance to the end of the text.
<Ctrl><Alt><+>	Change to high speed.
<Ctrl><Alt><->	Change to low speed.

WINBIOS Setup Menu

The WINBIOS Setup main menu is organized into four sections. Each of these sections corresponds to a section in this chapter.

Each section contains several icons. Clicking on each icon activates a specific AMIBIOS function. The WINBIOS Setup main windows and related functions are described on the next screen.

Main Windows The WINBIOS Setup main windows are:

- Setup, described in Section 1 has icons that permit you to set system configuration options such as date, time, hard disk type, floppy type, and many others,
 - Security, described in Section 2 has three icons that control AMIBIOS security features, and
 - Utilities, described in Section 3 sets the screen color and allows language changes,
 - Default, described in Section 4 has three icons that permit you to select a group of settings for all WINBIOS Setup options.
-

Section 1 Setup

Standard Setup

Standard Setup options are displayed by choosing the Standard icon from the WINBIOS Setup main menu. All Standard Setup options are described in this section.

Date/Time Select the Standard option. Select the Date and Time icon. The current values for each category are displayed. Enter new values through the keyboard.

Floppy Drive A: and B: Move the cursor to these fields via ↑ and ↓ and select the floppy type. The settings are *360 KB 5¼ inch*, *1.2 MB 5¼ inch*, *720 KB 3½ inch*, *1.44 MB 3½ inch*, or *2.88 MB 3½ inch*.

Primary Master, Primary Slave, Secondary Master, Secondary Slave Select one of these hard disk drive icons to configure the hard disk drive named in the option. Select *Auto* from the drive parameters screen to let AMIBIOS automatically configure the drive. A screen with a list of drive parameters appears. Click on *OK* to configure the drive.

Drive Type	How to Configure
SCSI	Select <i>Type</i> . Select <i>Not Installed</i> in the drive parameter screen. The SCSI drivers provided by the SCSI drive or SCSI host adapter manufacturer should allow you to configure the SCSI drive.
IDE	Select <i>Type</i> . Select <i>Auto</i> to let AMIBIOS determine the parameters. Click on <i>OK</i> when AMIBIOS displays the drive parameters. Select <i>LBA/Large Mode</i> . Select <i>On</i> if the drive has a capacity greater than 540 MB. Select <i>Block Mode</i> . Select <i>On</i> to allow block mode data transfers. Select <i>32-Bit Transfer</i> . Select <i>On</i> to allow 32-bit data transfers. Select the <i>PIO Mode</i> . It is best to select <i>Auto</i> to allow AMIBIOS to determine the PIO mode. If you select a PIO mode that is not supported by the IDE drive, the drive will not work properly. If you are absolutely certain that you know the drive's PIO mode, select PIO mode 0 - 5, as appropriate.
CD-ROM	Select <i>Type</i> . Select <i>CDROM</i> . Click on <i>OK</i> when AMIBIOS displays the drive parameters.
Standard MFM Drive	Select <i>Type</i> . You must know the drive parameters. Select the drive type that exactly matches your drive's parameters.
Non-Standard MFM Drive	Select <i>Type</i> . If the drive parameters do not match the drive parameters listed for drive types 1 - 46, select <i>User</i> and enter the correct hard disk drive parameters.

Cont'd

Standard Setup, Continued

Entering Drive Parameters You can also enter the hard disk drive parameters. The drive parameters are:

Parameter	Description
Type	The number for a drive with certain identification parameters.
Cylinders	The number of cylinders in the disk drive.
Heads	The number of heads.
Write Precompensation	The actual physical size of a sector gets progressively smaller as the track diameter diminishes. Yet each sector must still hold 512 bytes. Write precompensation circuitry on the hard disk compensates for the physical difference in sector size by boosting the write current for sectors on inner tracks. This parameter is the track number on the disk surface where write precompensation begins.
Landing Zone	This number is the cylinder location where the heads normally park when the system is shut down.
Sectors	The number of sectors per track. MFM drives have 17 sectors per track. RLL drives have 26 sectors per track. ESDI drives have 34 sectors per track. SCSI and IDE drives have even more sectors per track.
Capacity	The formatted capacity of the drive is the number of heads times the number of cylinders times the number of sectors per track times 512 (bytes per sector).

Cont'd

Standard Setup, Continued

Hard Disk Drive Types

Type	Cylinders	Heads	Write Precompensation	Landing Zone	Sectors	Capacity
1	306	4	128	305	17	10 MB
2	615	4	300	615	17	20 MB
3	615	6	300	615	17	31 MB
4	940	8	512	940	17	62 MB
5	940	6	512	940	17	47 MB
6	615	4	65535	615	17	20 MB
7	462	8	256	511	17	31 MB
8	733	5	65535	733	17	30 MB
9	900	15	65535	901	17	112 MB
10	820	3	65535	820	17	20 MB
11	855	5	65535	855	17	35 MB
12	855	7	65535	855	17	50 MB
13	306	8	128	319	17	20 MB
14	733	7	65535	733	17	43 MB
16	612	4	0	663	17	20 MB
17	977	5	300	977	17	41 MB
18	977	7	65535	977	17	57 MB
19	1024	7	512	1023	17	60 MB
20	733	5	300	732	17	30 MB
21	733	7	300	732	17	43 MB
22	733	5	300	733	17	30 MB
23	306	4	0	336	17	10 MB
24	925	7	0	925	17	54 MB
25	925	9	65535	925	17	69 MB
26	754	7	754	754	17	44 MB
27	754	11	65535	754	17	69 MB
28	699	7	256	699	17	41 MB
29	823	10	65535	823	17	68 MB
30	918	7	918	918	17	53 MB
31	1024	11	65535	1024	17	94 MB
32	1024	15	65535	1024	17	128 MB
33	1024	5	1024	1024	17	43 MB
34	612	2	128	612	17	10 MB
35	1024	9	65535	1024	17	77 MB
36	1024	8	512	1024	17	68 MB
37	615	8	128	615	17	41 MB
38	987	3	987	987	17	25 MB
39	987	7	987	987	17	57 MB
40	820	6	820	820	17	41 MB
41	977	5	977	977	17	41 MB
42	981	5	981	981	17	41 MB
43	830	7	512	830	17	48 MB
44	830	10	65535	830	17	69 MB
45	917	15	65535	918	17	114 MB
46	1224	15	65535	1223	17	152 MB
AMIBIOS automatically sets IDE drive parameters. Select USER to enter MFM, ESDI, or RLL drive parameters. Select Not Installed for SCSI drives. Select CDROM for CD-ROM drives.						

Advanced Setup

Advanced Setup options are displayed by choosing the Advanced icon from the WINBIOS Setup main menu. All Advanced Setup options are described in this section.

System Keyboard This option does not specify if a keyboard is attached to the computer. Rather, it specifies if error messages are displayed if a keyboard is not attached. This option permits you to configure workstations with no keyboards. The settings are *Absent* or *Present*. The Optimal and Fail-Safe default settings are *Present*.

Setup Color Scheme This option specifies the color scheme for the WINBIOS Setup utility. The settings are *LCD*, *Army*, *Pastel*, or *Sky*. The Optimal and Fail-Safe default settings are *LCD*.

PS/2Mouse Support Set this option to *Enabled* to enable AMIBIOS support for a PS/2-type mouse.. The settings are *Enabled* or *Disabled*. The Optimal and Fail-Safe default settings are *Enabled*.

Display BIOS POST Messages Set this option to *Yes* to display the standard AMIBIOS messages during the BIO Power On Self Test (POST) phase. The settings are:

Setting	Description
<i>Yes</i>	The standard messages that AMIBIOS displays before booting the system will appear on the system monitor.
<i>No</i>	The standard AMIBIOS POST messages will not appear on the system monitor.

Cont'd

Advanced Setup, Continued

Display Add-On ROM Messages Set this option to *Yes* to display any additional screen messages from an option ROM. This option can only be selected if the **Display BIOS POST Message** option is set to *No*. The settings are:

Setting	Description
<i>Yes</i>	Display messages from an option ROM.
<i>No</i>	Do not display messages from an option ROM.

The Optimal and Fail-Safe default settings are *No*.

Pause on Config. Screen This option specifies the length of time that the AMIBIOS configuration screen appears. The settings are 2 (*seconds*), 3, 4, 5, 6, 7, 8, 9, 10, 11, 12, 13, 14, or *Disabled*. The Optimal and Fail-Safe default settings are *Disabled*.

Boot Up Num Lock Set this option to *On* to turn the Num Lock key On at system boot. The settings are *On* or *Off*. The Optimal and Fail-Safe default settings are *On*.

Password Check This option enables the password check option every time the system boots or the end user runs Setup. If *Always* is chosen, a user password prompt appears every time the computer is turned on. If *Setup* is chosen, the password prompt appears if WINBIOS is executed. The Optimal and Power-On defaults are *Setup*.

Boot To OS/2 Set this option to *Yes* if running OS/2 operating system and using more than 64 MB of system memory on the motherboard. The settings are *Yes* or *No*. The Optimal and Fail-Safe default settings are *No*.

Floppy Drive Seek Set this option to *Enabled* to specify that floppy drive A: will perform a Seek operation at system boot. The settings are *Disabled* or *Enabled*. The Optimal and Fail-Safe default settings are *Disabled*.

Cont'd

Advanced Setup, Continued

Floppy Drive Swap Set this option to *Enabled* to permit drives A: and B: to be swapped. The settings are *Enabled* or *Disabled*. The Optimal and Fail-Safe default settings are *Disabled*.

Floppy Access Control This option specifies the read/write access that is set when booting from a floppy drive. The settings are *Read/Write* or *Read-Only*. The Optimal and Fail-Safe default settings are *Read/Write*.

Hard Disk Access Control This option specifies the read/write access that is set when booting from a hard disk drive. The settings are *Read/Write* or *Read-Only*. The Optimal and Fail-Safe default settings are *Read/Write*.

S.M.A.R.T. For Hard Disks Set this option to *Enabled* to permit AMIBIOS to use the SMART (Self Monitoring Analysis and Reporting Technology) protocol for reporting server system information over a network. The settings are *Enabled* or *Disabled*. The Optimal and Fail-Safe default settings are *Disabled*.

Primary Master ARMD Emulator As

Primary Slave ARMD Emulator As

Secondary Master ARMD Emulator As

Secondary Slave ARMD Emulator As These options specify the type of standard PC drive that an ARMD drive will use when attached as a master or slave to the specified IDE channel. The settings are *Auto* (AMIBIOS automatically determines the correct type of drive emulation), *Floppy*, or *Hard Disk*. The Optimal and Fail-Safe default settings are *Auto*.

If *Auto* is selected, AMIBIOS configures ARMD drives as follows:

Type of ARMD Device	Drive Emulation Configured
LS120	Floppy
Iomega Zip drive	Hard Disk
Magneto-Optical drive	Hard Disk

Cont'd

Advanced Setup, Continued

1st Boot Device This option sets the type of device for the first boot drives that the AMIBIOS attempts to boot from after AMIBIOS POST completes. The settings are *Disabled, Network, Floppy, ARMD-FDD, ARMD-HDD, ATAPI, SCSI, CDROM, 1st IDE-HDD, 2nd IDE-HDD, 3rd IDE HDD, or 4th IDE-HDD*. The Optimal and Fail-Safe default settings are *Disabled*.

2nd Boot Device This option sets the type of device for the second boot drives that the AMIBIOS attempts to boot from after AMIBIOS POST completes. The settings are *Disabled, Floppy, ARMD-FDD, ARMD-HDD, ATAPI, SCSI, CDROM, 1st IDE-HDD, 2nd IDE-HDD, 3rd IDE HDD, or 4th IDE-HDD*. The Optimal and Fail-Safe default settings are *Disabled*.

3rd Boot Device This option sets the type of device for the third boot drives that the AMIBIOS attempts to boot from after AMIBIOS POST completes. The settings are *Disabled, Floppy, ARMD-FDD, ARMD-HDD, ATAPI, CDROM, 1st IDE-HDD, 2nd IDE-HDD, 3rd IDE HDD, or 4th IDE-HDD*. The default settings are *ARMD-HDD*.

4th Boot Device This option sets the type of device for the third boot drives that the AMIBIOS attempts to boot from after AMIBIOS POST completes. The settings are *Disabled, Floppy, ARMD-FDD, ARMD-HDD, ATAPI, CDROM, 1st IDE-HDD, 2nd IDE-HDD, 3rd IDE HDD, or 4th IDE-HDD*. The default settings are *Disabled*.

Try Other Boot Devices Set this option to *Yes* to instruct AMIBIOS to attempt to boot from any other drive in the system if it cannot find a boot drive among the drives specified in the **1st Boot Device, 2nd Boot Device, 3rd Boot Device, and 4th Boot Device** options. The settings are *Yes* or *No*. The Optimal and Fail-Safe default settings are *Yes*.

Cont'd

Advanced Setup, Continued

External Cache Set this option to *Enabled* to enable L2 secondary (external) cache memory. The settings are *Enabled* or *Disabled*. The Optimal default setting is *Enabled*. The Fail-Safe default setting is *Disabled*.

Caching Controller Set this option to *Yes* if a cache controller is installed in the computer.

Setting	Description
<i>Absent</i> (the default setting)	To comply with the PCI specifications, PCI adapter cards must be reset every time the CPU is reset. When the end user forces a soft reset by pressing <Ctrl> <Alt> , only the CPU is reset. When this option is set to No, all soft resets are converted to hard resets, and all PCI adapter cards are reset when the CPU is reset.
<i>Present</i>	Soft resets still behave like soft resets when Yes is selected. Select this option if a caching controller is installed in the computer. Soft resets must not generate a hard reset if a caching controller is used. If a hard reset is generated, a PCI caching controller card cannot flush data from cache memory to a hard disk drive before the reset.

Video Shadow C000,32K This option controls the location of the contents of video ROM. The settings are:

Setting	Description
<i>Shadow</i>	The contents of the video ROM area (C0000h - C7FFFh) are written to the corresponding address in RAM.
<i>Cached</i>	The contents of the video ROM area (C0000h - C7FFFh) are written to the corresponding RAM address and may be read from or written to cache memory.
<i>Disabled</i>	The video ROM is not copied to RAM. The contents of the video ROM cannot be read from or written to cache memory.

The Optimal default setting is *Cached*. The Fail-Safe default setting is *Disabled*.

Shadow C800,16K

Shadow CC00,16K

Shadow D000,16K

Shadow D400,16K

Shadow D800,16K

Shadow DC00,16K These options enable shadowing of the contents of the ROM area in the option title.

Setting	Description
<i>Shadow</i>	The contents of the ROM area are written to the corresponding address in RAM for faster execution.
<i>Cached</i>	The contents of the ROM area are written to the corresponding RAM address and can be read from or written to cache memory.
<i>Disabled</i>	The ROM is not copied to RAM. The contents of the video ROM cannot be read from or written to cache memory.

The Optimal and Fail-Safe settings are *Disabled*.

Chipset Setup

The AMIBIOS Setup options described in this section are selected by choosing the Chipset Setup icon from the Setup section on the WINBIOS Setup main menu.

USB Function Set this option to *Enabled* to enable the system BIOS USB (Universal Serial Bus) functions. The settings are *Enabled* or *Disabled*. The Optimal and Fail-Safe default settings are *Enabled*.

USB Keyboard/Mouse Legacy Support Set this option to *Enabled* to enable USB support for legacy keyboards and mice. The settings are *Enabled* or *Disabled*. The Optimal and Fail-Safe default settings are *Enabled*.

ISA 8 Bit I/O Recovery Time This option specifies the length of the delay that is added to the CPU cycle between consecutive 8-bit I/O operations. The length of the delay is related to the CPU type and frequency. The settings are *1 Sysclock, 2 Sysclocks, 3 Sysclocks, 4 Sysclocks, 5 Sysclocks, 6 Sysclocks, 8 Sysclocks, or Disabled*. The Optimal and Fail-Safe default settings are *Disabled*.

ISA 16 Bit I/O Recovery This option specifies the length of the delay that is added to the CPU cycle between consecutive 16-bit I/O operations. The length of the delay is related to the CPU type and frequency. The settings are *1 Sysclock, 2 Sysclocks, 3 Sysclocks, 4 Sysclocks, or Disabled*. The Optimal and Fail-Safe default settings are *Disabled*.

Power Management Setup

The AMIBIOS Setup options described in this section are selected by choosing the Power Management Setup icon from the Setup section on the AMIBIOS Setup main menu.

Power Management/APM Set this option to *Enabled* to enable the Intel Triton 2 power management features and APM (Advanced Power Management). The settings are *Enabled*, *Inst-On (instant-on)*, or *Disabled*. The Optimal and Fail-Safe default settings are *Disabled*.

Instant On Support Set this option to *Enabled* to enable AMIBIOS support for the Intel InstantON specification. The settings are *Enabled* or *Disabled*. The Optimal and Fail-Safe default settings are *Disabled*.

Green PC Monitor Power State This option specifies the power state that the green PC-compliant video monitor enters when AMIBIOS places it in a power saving state after the specified period of display inactivity has expired. The settings are *Off*, *Standby*, *Suspend*, or *Disabled*. The Optimal and Fail-Safe default settings are *Standby*.

Video Power Down Mode This option specifies the power conserving state that the VESA VGA video subsystem enters after the specified period of display inactivity has expired. The settings are *Disabled*, *Standby*, or *Suspend*. The Optimal and Fail-Safe default settings are *Disabled*.

Hard Disk Power Down Mode This option specifies the power conserving state that the hard disk drive enters after the specified period of hard drive inactivity has expired. The settings are *Disabled*, *Standby*, or *Suspend*. The Optimal and Fail-Safe default settings are *Disabled*.

Hard Disk Timeout (Minute) This option specifies the length of a period of hard disk drive inactivity. When this length of time expires, the computer enters power-conserving state specified in the **Hard Disk Power Down Mode** option (see the previous screen). The settings are *Disabled* and *1 Min.* through *15 Min* in 1 minute intervals. The Optimal and Fail-Safe default settings are *Disabled*.

Standby/Suspend Timer Unit This option specifies the unit of time used for the Standby and Suspend timeout periods. The settings are *4 msec*, *4 sec*, *32 sec*, or *4 min*. The Optimal and Fail-Safe default settings are *4 min*.

Standby Timeout This option specifies the length of a period of system inactivity while in Full power on state. When this length of time expires, the computer enters Standby power state. The settings are *Disabled*, *4 min*, *8 min*, *up to and including 508 minutes*, *in increments of 4 minutes*. The Optimal and Fail-Safe default settings are *Disabled*.

Suspend Timeout This option specifies the length of a period of system inactivity while in Standby state. When this length of time expires, the computer enters Suspend power state. The settings are *Disabled*, *4 min*, *8 min*, *up to and including 508 minutes*, *in increments of 4 minutes*. The Optimal and Fail-Safe default settings are *Disabled*.

Cont'd

Power Management Setup, Continued

Slow Clock Ratio This option specifies the speed at which the system clock runs in power saving states. The settings are expressed as a ratio between the normal CPU clock speed and the CPU clock speed when the computer is in the power-conserving state. The settings are *0-12.5%*, *12.5-25%*, *25-37.5%*, *37.5-50%*, *50-62.5%*, *62.5-75%*, or *75-87.5%*. The Optimal and Fail-Safe defaults are *1:8*.

Display Activity This option specifies if AMIBIOS is to monitor display activity for power conservation purposes. When this option is set to *Monitor* and there is no display activity for the length of time specified in the **Standby Timeout (Minutes)** option, the computer enters a power savings state. The settings are *Monitor* or *Ignore*. The Optimal and Fail-Safe default settings are *Ignore*.

Device 6 (Serial Port 1)

Device 7 (Serial Port 2)

Device 8 (Parallel Port)

Device 5 (Floppy Disk)

Device 0 (Primary Master IDE)

Device 1 (Primary Slave IDE)

Device 2 (Secondary Master IDE)

Device 3 (Secondary Slave IDE) When set to *Monitor*, these options enable event monitoring on the specified hardware interrupt request line. If set to *Monitor* and the computer is in a power saving state, AMIBIOS watches for activity on the specified IRQ line. The computer enters the Full On state if any activity occurs. AMIBIOS reloads the Standby and Suspend timeout timers if activity occurs on the specified IRQ line.

The settings for each of these options are *Monitor* or *Ignore*. The Optimal and Fail-Safe default settings are *Ignore*.

PCI/PnP Setup

Choose the PCI/PnP Setup icon from the WINBIOS Setup screen to display the PCI and Plug and Play Setup options, described below.

Plug and Play-Aware OS Set this option to *Yes* if the operating system in this computer is aware of and follows the Plug and Play specification. Windows 95 is PnP-aware. The settings are *Yes* or *No*. The Optimal and Fail-Safe default settings are *No*.

PCI VGA Palette Snoop When this option is set to *Enabled*, multiple VGA devices operating on different buses can handle data from the CPU on each set of palette registers on every video device. Bit 5 of the command register in the PCI device configuration space is the VGA Palette Snoop bit (0 is disabled). For example: if there are two VGA devices in the computer (one PCI and one ISA) and the VGA Palette Snoop bit is:

Snoop Bit	Action
<i>Disabled</i>	Data read and written by the CPU is only directed to the PCI VGA device's palette registers.
<i>Enabled</i>	Data read and written by the CPU is directed to the both the PCI VGA device palette registers and the ISA VGA device palette registers, and the palette registers of both devices can be identical.

This option must be set to *Enabled* if an ISA adapter card installed in the system uses VGA palette snooping. The Optimal and Fail-Safe default settings are *Disabled*.

Allocate IRQ to PCI VGA Set this option to *Yes* to allocate an IRQ to a VGA adapter card that uses the PCI local bus. The settings are *Yes* or *No*. The Optimal and Fail-Safe default settings are *Yes*.

PCI Slot-1 Latency Timer

PCI Slot-2 Latency Timer

PCI Slot-3 Latency Timer

PCI Slot-4 Latency Timer These options specify the latency timings (in PCI clocks) for PCI devices installed in the four PCI expansion slots. The settings are 32, 64, 96, 128, 160, 192, 224, or 248. The Optimal and Fail-Safe default settings are 64.

USB Device Latency Timer This option specifies the latency timings (in PCI clocks) for USB devices installed in the computer. The settings are 32, 64, 96, 128, 160, 192, 224, or 248. The Optimal and Fail-Safe default settings are 64.

USB Device IRQ Preference These options specify the IRQ priority for USB devices installed in the computer. The settings are *Auto*, *IRQ5*, *IRQ9*, *IRQ10*, *IRQ11*, *IRQ14*, and *IRQ15*, in priority order. If *Auto* is selected, AMIBIOS automatically determines the optimal IRQ priority order. The Optimal and Fail-Safe default settings are *Auto*.

PCI Slot-1 IRQ Preference

PCI Slot-2 IRQ Preference

PCI Slot-3 IRQ Preference

PCI Slot-4 IRQ Preference These options specify the IRQ priority for PCI devices installed in the four PCI expansion slots. The settings are *Auto*, *IRQ5*, *IRQ9*, *IRQ10*, *IRQ11*, *IRQ 14*, and *IRQ15*, in priority order. If *Auto* is selected, AMIBIOS automatically determines the optimal IRQ priority order. The Optimal and Fail-Safe default settings are *Auto*.

Cont'd

IRQ3
 IRQ4
 IRQ5
 IRQ7
 IRQ9
 IRQ10
 IRQ11
 IRQ12
 IRQ14
 IRQ15

These options specify the bus that the specified IRQ line is used on. These options allow you to reserve IRQs for legacy ISA adapter cards. These options determine if AMIBIOS should remove an IRQ from the pool of available IRQs passed to devices that are configurable by the system BIOS. The available IRQ pool is determined by reading the ESCD NVRAM. If more IRQs must be removed from the pool, the end user can use these options to reserve the IRQ by assigning an *ISA* setting to it. Onboard I/O is configured by AMIBIOS. All IRQs used by onboard I/O are configured as *PCI*, *PnP*, or *PCI/PnP*. IRQ14 and 15 will not be available if the onboard Triton 2 PCI IDE is enabled. If all IRQs are set to *ISA* and IRQ14 and 15 are allocated to the onboard PCI IDE, IRQ9 will still be available for PCI and PnP devices, because at least one IRQ must be available for PCI and PnP devices. The settings are *ISA*, *PnP*, *PCI/PnP*, or *PCI*. The Optimal and Fail-Safe default settings are:

Option	Optimal Default	Fail-Safe Default
IRQ3	PnP	PCI/PnP
IRQ4	PnP	PCI/PnP
IRQ5	PCI/PnP	PCI/PnP
IRQ7	PnP	PCI/PnP
IRQ9	PCI/PnP	PCI/PnP
IRQ10	PCI/PnP	PCI/PnP
IRQ11	PCI/PnP	PCI/PnP
IRQ12	PnP	PnP
IRQ14	PCI/PnP	PCI/PnP
IRQ5	PCI/PnP	PCI/PnP

DMA Channel 0
 DMA Channel 1
 DMA Channel 3
 DMA Channel 5
 DMA Channel 6

DMA Channel 7 These options allow you to specify the bus type used by each DMA channel. The settings are *PnP* or *ISA*. The Optimal and Fail-Safe default settings are *PnP*.

Reserved ISA Card Memory Size This option specifies the size of the memory area reserved for legacy ISA adapter cards. The settings are *Disabled*, *16K*, *32K*, or *64K*. The Optimal and Fail-Safe default settings are *Disabled*.

Reserved ISA Card Memory Address This option specifies the beginning address (in hex) of the reserved memory area. The specified ROM memory area is reserved for use by legacy ISA adapter cards.

The settings are *C0000*, *C4000*, *C8000*, *CC000*, *D0000*, *D4000*, *D8000*, or *DC000*. The Optimal and Fail-Safe default settings are *C4000*.

Peripheral Setup

Choose the Peripheral Setup icon from the WINBIOS Setup screen to display the Peripheral Setup options, described below.

Onboard Floppy Controller Set this option to *Enabled* to enable the floppy drive controller on the motherboard. The settings are *Enabled* or *Disabled*. The Optimal and Fail-Safe default settings are *Enabled*.

Onboard Primary/Secondary IDE This option specifies the IDE channels on the onboard IDE controller that will be used. The settings are *Disabled*, *Primary*, *Secondary*, or *Both*. The Optimal and Fail-Safe default settings are *Disabled*.

Onboard IDE Bus Master Set this option to *Enabled* to specify that the IDE controller on the PCI local bus includes a bus mastering capability. The settings are *Enabled* or *Disabled*. The Optimal and Fail-Safe default settings are *Disabled*.

Primary Prefetch

Secondary Prefetch These options specify the IDE channel or channel where prefetch is enabled. The settings are *Disabled*, *Master*, *Slave*, or *Both*. There are no default settings.

Offboard PCI/ISA IDE Card This option specifies if an offboard PCI IDE controller adapter card is installed in the computer. You must choose *ISA* if an ISA IDE card is installed or the PCI expansion slot on the motherboard where the offboard PCI IDE controller is installed. If an offboard ISA or PCI IDE controller is used, the onboard IDE controller is automatically disabled. The settings are *Auto* (*AMIBIOS automatically determines where the offboard PCI IDE controller adapter card is installed*), *Absent*, *ISA*, *Slot1*, *Slot2*, *Slot3*, or *Slot4*. The Optimal And Fail-Safe default settings are *Auto*.

In the AMIBIOS for the Intel Triton II ISA chipset, this option forces IRQ14 and IRQ15 to a PCI slot on the PCI Local bus. This is necessary to support non-compliant ISA IDE controller adapter cards.

If an offboard PCI IDE controller adapter card is installed in the computer, you must also set the **Offboard PCI IDE Primary IRQ** and **Offboard PCI IDE Secondary IRQ** options.

Offboard Primary/Secondary This option specifies the IDE controller channels used by the offboard IDE adapter card. The settings are *Disabled*, *Primary*, *Secondary*, or *Both*. There are no Optimal and Fail-Safe default settings.

Offboard PCI IDE Primary IRQ

Offboard PCI IDE Secondary IRQ These options specify the PCI interrupt used by the primary or secondary IDE channel on the offboard PCI IDE controller. The settings are *Disabled*, *Hardwired*, *INTA*, *INTB*, *INTC*, or *INTD*. The Optimal and Fail-Safe default settings are *Disabled*.

Onboard Serial Port1 IRQ This option specifies the IRQ used for serial port1. The settings are *IRQ4* or *Disabled*. The Optimal default setting is *IRQ4*. The Fail-Safe default setting is *Disabled*.

Cont'd

Peripheral Setup, Continued

Onboard Serial Port1 Address This option specifies the base I/O port address of serial port 1. The settings are *Auto* (*AMIBIOS automatically determines the correct base I/O port address*), *Disabled*, *3F8h*, or *3E8h*. The Optimal default setting is *3F8h*. The Fail-Safe default setting is *Disabled*.

Onboard Serial Port1 FIFO Set this option to *Enabled* to enable the serial port1 FIFO buffer. The settings are *Enabled* or *Disabled*. The Optimal and Fail-Safe default settings are *Disabled*.

Onboard Serial Port2 IRQ This option specifies the IRQ used for serial port2. The settings are *IRQ3* or *Disabled*. The Optimal default setting is *IRQ3*. The Fail-Safe default setting is *Disabled*.

Onboard Serial Port2 Address This option specifies the base I/O port address of serial port 2. The settings are *Auto* (*AMIBIOS automatically determines the correct base I/O port address*), *Disabled*, *2F8h*, or *2E8h*. The Optimal default setting is *3F8h*. The Fail-Safe default setting is *Disabled*.

Onboard Serial Port2 FIFO Set this option to *Enabled* to enable the serial port2 FIFO buffer. The settings are *Enabled* or *Disabled*. The Optimal and Fail-Safe default settings are *Disabled*.

Onboard Serial Port2 Mode This option specifies the serial port 2 mode. The settings are *Normal* or *IrDA (Infrared)*. The Optimal and Fail-Safe default settings are *Normal*.

IR Duplex Mode This option selects the infrared transmission method. The settings are *Full* or *Half*. The Optimal and Fail-Safe default settings are *Full*.

IrDA Protocol This option specifies the infrared standard used for the serial port2 infrared capability. The settings are *1.6 us* or *3/16*. The Optimal and Fail-Safe default settings are unspecified because *IR* is not the default setting for the **Serial Port2 Mode** option.

Onboard Parallel Port IRQ This option specifies the IRQ used by the parallel port. The settings are *Disabled*, *IRQ 5*, or *IRQ 7*. The Optimal default setting is *IRQ 7*. The Fail-Safe default setting is *Disabled*.

Cont'd

Peripheral Setup, Continued

Onboard Parallel Port Address This option specifies the base I/O port address of the parallel port on the motherboard. The settings are *Disabled*, *378h*, or *278h*. The Optimal default setting is *378h*. The Fail-Safe default setting is *Disabled*.

Onboard **Parallel Port Mode** This option specifies the parallel port mode. The Optimal default setting is *Normal*. The Fail-Safe default setting is *Disabled*. The settings are:

Setting	Description
<i>Normal</i>	The normal parallel port mode is used.
<i>SPP/ EPP</i>	The parallel port can be used with devices that adhere to the SPP or Enhanced Parallel Port (EPP) specification. EPP uses the existing parallel port signals to provide asymmetric bidirectional data transfer driven by the host device.
<i>ECP</i>	The parallel port can be used with devices that adhere to the Extended Capabilities Port (ECP) specification. ECP uses the DMA protocol to achieve data transfer rates up to 2.5 Megabits per second. ECP provides symmetric bidirectional communication.

EPP Version This option specifies the Enhanced Parallel Port specification version number that is used if the **Parallel Port Mode** option is set to *EPP*. *This option can only be selected if the Parallel Port Mode option is set to EPP*

The settings are *1.7* or *1.9*. There are no Optimal and Fail-Safe default settings because the default setting for the **Parallel Port Mode** option is not *EPP*.

Parallel Port DMA Channel This option is only available if the setting for the **Parallel Port Mode** option is *ECP*. This option sets the DMA channel used by the parallel port. The settings are (*DMA Channel*) *0*, *1* or *3*. The Optimal and Fail-Safe default settings are *3*.

Section 2 Security

Three icons appear in this part of the WINBIOS Setup screen:

- Supervisor (Password),
 - User (Password), and
 - Anti-Virus.
-

Two Levels of Passwords Both the Supervisor and the User icons configure password support. If you use both, the Supervisor password must be set first.

The system can be configured so that all users must enter a password every time the system boots or when WINBIOS Setup is executed, using either or both the Supervisor password or User password.

AMIBIOS Password Support

The Supervisor and User icons activate two different levels of password security.

If WINBIOS Setup has an optional password feature. The system can be configured so that all users must enter a password every time the system boots or when WINBIOS Setup is executed.

Setting a Password

The password check option is enabled in Advanced Setup (see the Advanced Setup section) by choosing either *Always* (the password prompt appears every time the system is powered on) or *Setup* (the password prompt appears only when WINBIOS is run). The password is encrypted and stored in NVRAM.

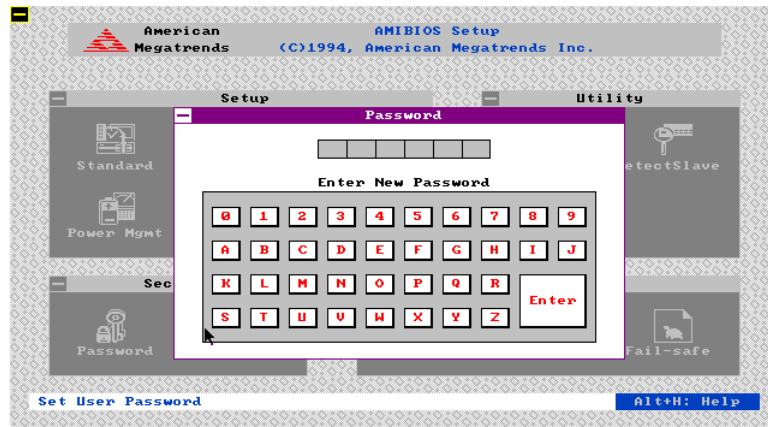

As shown on the above screen, you are prompted for a 1 – 6 character password. You can either type the password on the keyboard or select each letter of the password, one at a time, using the mouse. The password does not appear on the screen when typed. Make sure you write it down. If you forget it, you must drain NVRAM and reconfigure.

If You Do Not Want to Use a Password Just press <Enter> when the password prompt appears.

Changing a Password

Select the *Supervisor* or *User* icon from the Security section of the WINBIOS Setup main menu. Enter the password and press <Enter>. The screen does not display the characters entered. After the new password is entered, retype the new password as prompted and press <Enter>.

If the password confirmation is incorrect, an error message appears. If the new password is entered without error, press <Esc>. The password is stored in NVRAM after WINBIOS completes. The next time the system boots, a password prompt appears if the password function is present and enabled.

Remember the Password Keep a record of the new password when the password is changed. If you forget the password, you must erase the system configuration information in NVRAM (Non-Volatile Random Access Memory).

Anti-Virus

When this icon is selected from the Security section of the WINBIOS Setup main menu, AMIBIOS issues a warning when any program (or virus) issues a Disk Format command or attempts to write to the boot sector of the hard disk drive. The settings are *Enabled* or *Disabled*. If enabled, the following appears when a write is attempted to the boot sector. You may have to type *N* several times to prevent the boot sector write.

```
Boot Sector Write!!!  
Possible VIRUS: Continue (Y/N)? _
```

The following appears after any attempt to format any cylinder, head, or sector of any hard disk drive via the BIOS INT 13 Hard Disk Drive Service:

```
Format!!!  
Possible VIRUS: Continue (Y/N)? _
```

Section 3 Utility

The following icons appear in this section of the WINBIOS Setup main screen:

Detect IDE Choose this option to let AMIBIOS automatically detect and configure the parameters for an IDE hard disk drive.

Language If this feature is enabled, you can select WINBIOS Setup messages in different languages.

Section 4 Default

The icons in this section permit you to select a group of settings for all WINBIOS Setup options. Not only can you use these icons to quickly set system configuration parameters, you can choose a group of settings that have a better chance of working when the system is having configuration-related problems.

Original Choose the Original icon to return to the system configuration values present in WINBIOS Setup when you first began this WINBIOS Setup session.

Optimal You can load the optimal default settings for the WINBIOS by selecting the Optimal icon. The Optimal default settings are best-case values that should optimize system performance. If NVRAM is corrupted, the Optimal settings are loaded automatically.

Fail-Safe You can load the Fail-Safe WINBIOS Setup option settings by selecting the Fail-Safe icon from the Default section of the WINBIOS Setup main menu. The Fail-Safe settings provide far from optimal system performance, but are the most stable settings. Use this option as a diagnostic aid if the system is behaving erratically.

3 Programming the Flash ROM

All versions of the Apollo IV motherboard use Flash EPROM to store the system BIOS. The advantage of Flash EPROM is the EPROM chip does not have to be replaced to update the BIOS. The end user can actually reprogram the BIOS, using a ROM file supplied by American Megatrends.

Programming the Flash EPROM

Step	Action
1	Turn power off. Make sure the computer has a working speaker.
2	Insert the floppy disk with the S772P.ROM file in drive A:.
3	Before DOS boots, press and hold down the <Ctrl> and <Home> keys to reprogram the Flash EPROM-based AMIBIOS. The bootblock code immediately reads the A: drive, looking for the new BIOS information.
4	When the flash ROM has successfully been programmed, the computer will reboot.

Bootblock BIOS Actions When you reprogram from system boot, the bootblock BIOS code:

Reads S772P.ROM from the root directory of the floppy disk in drive A:.

Erases the Flash EPROM.

Programs the Flash EPROM with the data read from the floppy disk in drive A:.

Generates a CPU reset, rebooting the computer.

The bootblock part of the Flash EPROM is not programmed. Should you inadvertently open the disk drive door or turn power off to the computer while programming the Flash EPROM, the bootblock will be unaffected. Simply turn power back on and begin the Flash ROM programming process again.

Cont'd

Programming the Flash ROM, Continued

S772P.ROM S772P.ROM resides on a floppy disk and contains the updated main BIOS code. American Megatrends will provide this file when the AMIBIOS for the Apollo IV ISA motherboard must be updated.

S772P.ROM must be present in the root directory of the floppy disk before the onboard Flash EPROM can be reprogrammed. The file that has the main BIOS code must be named S772P.ROM.

Sequence of Operation The sequence of operation and expected behavior of the bootblock BIOS code is:

Step	Expected behavior
1 Look for floppy disk.	The system beeps one time before the BIOS attempts to read from floppy drive A:.
2 Look for S772P.ROM on the floppy disk.	S772P.ROM must be in the root directory of the floppy disk in drive A:. There is no beep if successful.
3 Read the floppy disk.	The floppy disk is read. There is no beep if this step is successful.
4 Check for BIOS file size.	The BIOS file size is checked. There is no beep if this step is successful.
5 Check for Flash EPROM.	The BIOS looks for an Intel i28F001BX-T Flash EPROM. It does not beep if this step is successful.
6 Erase the Flash EPROM.	Two beeps sound when the BIOS begins erasing the Flash EPROM.
7 Program the Flash EPROM.	Three beeps sound when the AMIFlash Code begins reprogramming the Flash EPROM.
8 Continue programming the Flash EPROM.	Four beeps sound when reprogramming has been successfully completed.
9 AMIFlash does a reset.	A CPU reset is generated to reboot the computer.

Programming the Flash ROM, Continued

Beep Codes The bootblock code produces a series of beeps during Flash ROM programming to:

- signify completion of a step (as shown on the previous screen), or to
- signal an error.

Error beeps are arranged in a coded sequence and have different meanings depending on when they occur. The error beep codes and when they can occur are:

Number of Beeps	Description
1	Insert diskette in floppy drive A:.
2	The AMIBOOT.ROM file was not found in the root directory of the diskette in floppy drive A:.
3	Base memory error.
4	Flash program successful.
5	Floppy read error.
6	Keyboard controller BAT command failed.
7	No Flash EPROM detected.
8	Floppy controller failure.
9	Boot Block BIOS checksum error.
10	Flash erase error.
11	Flash program error.
12	AMIBOOT.ROM file size error.
Continuous beep	Flash Programming successful. Turn power off. The turn power on again to restart.

Bootblock Code Checkpoint Codes

Code	Description
E0h	Verify the bootblock BIOS checksum. Disable the internal cache, DMA, and interrupt controllers. Initialize the system timer. Start memory refresh.
E1h	Initialize the chipset registers. Set the BIOS size to 128K. Make the 512 KB base memory available.
E2h	Test the base 64 KB of system memory. Send the BAT command to the keyboard controller. Make sure that <Ctrl> <Home> was pressed. Verify the main system BIOS checksum.
E3h	The main system BIOS is good. Transfer control to the main system BIOS.
E4h	Start the memory test.
E5h	The memory test is over. Initialize the interrupt vector table.
E6h	Initialize the DMA and interrupt controllers.
E7h	Determine the CPU internal clock frequency.
E8h	Initialize the I/O chipset, if any.
E9h	Program the CPU clock-dependent chip set parameters.
EAh	Enable the timer and the floppy diskette interrupt. Enable the internal cache. Copy the bootblock BIOS and pass control to the bootblock BIOS in the 0000h segment.
EDh	Initialize the floppy drive.
EEh	Look for a diskette in drive A:. Read the first sector of the diskette.
EFh	Floppy read error.
F0h	Search for AMIBOOT.ROM in the root directory of the floppy diskette in drive A:.
F1h	The AMIBOOT.ROM file is not in the root directory.
F2h	Read the FAT. Analyze the FAT to find the clusters occupied by the AMIBOOT.ROM.
F3h	Start reading the AMIBOOT.ROM file, cluster by cluster.
F4h	The AMIBOOT.ROM file is not the correct size.
F5h	Disable the internal cache. Raise the Vpp. Enable Flash write and reset the Flash ROM.
FBh	Detect the flash type.
FCh	Start erasing flash blocks.
FDh	Program the Flash ROM in the E0000-EFFFFh region.
FEh	Start programming Flash at F0000-FFFFF region.
FFh	Flash programming is successful. The computer reboots.